

GC-1270-60-TO-200-A	
Straight stripe gain chip for 1240-1300nm tuning range	
	<b>Features:</b> <ul style="list-style-type: none"> <li>• Optimized for wavelength locked operation in external cavity system</li> <li>• Broad hopping free tuning range</li> <li>• High Signal/ASE ratio</li> </ul>
	<b>Application:</b> <ul style="list-style-type: none"> <li>• External cavity tunable laser</li> </ul>
	<h2 style="margin: 0;">Specification</h2>
DATE: 02 <sup>th</sup> January 2015	

RECOMMENDED OPERATING POINT				
Parameter	Min	Typ	Max	Unit
Current		800	900*	mA
Forward voltage		1.6	1.8	V
Heatsink temperature	20	25	30	C

TUNABILITY				
@ CW, recommended operating point, external cavity in Littman configuration with ≈10% feedback				
Parameters	Min	Typ	Max	Unit
Wavelength of maximum power ( $\lambda_{MP}$ )	1255	1270	1285	
Optical output power @ $\lambda_{MP}$	150	200		mW
Central wavelength of tuning range	1255	1270	1285	nm
Tuning range width		60		nm

AMPLIFIED SPONTANEOUS EMISSION (ASE)				
Tested for each device @ CW, recommended operating point, without external cavity				
Parameter	Min	Typ	Max	Unit
Optical power		2.5		mW
Mean wavelength		1265		nm
Bandwidth @ -3dB*		22		nm
Fast axis beam divergence @ -3dB	30	33	38	deg.
Slow axis beam divergence @ -3dB	4	5	10	deg.

\* Radiation coupled in single-mode fiber without lens and measured by OSA with 1 nm resolution.

CHIP PARAMETERS				
Parameter	Min	Typ	Max	Unit
Chip length		3		mm
Back-reflection from back facet (HR-coated)	99			%
Back-reflection from front facet (AR-coated)		0.02		%

## TYPICAL PERFORMANCE IN EXTERNAL CAVITY (EC)

@ CW, 25°C heatsink temperature, Littman configuration with ≈10% feedback

**Optical spectra @ 800mA (res. 0.5 nm)**

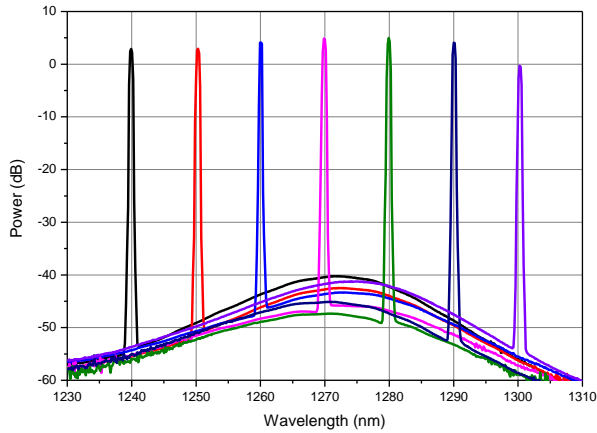

**Optical spectrum @ 800mA (res. 10 pm)**

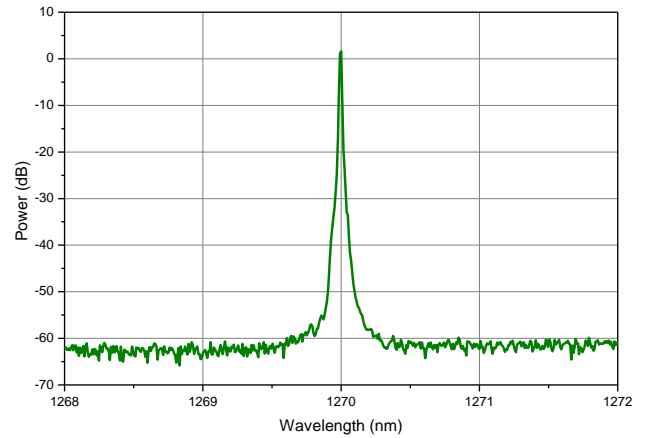

**Output power spectra**

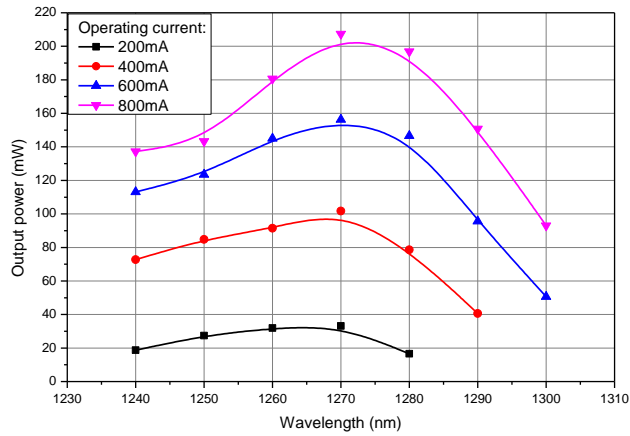

**Signal/ASE ratio @ 800mA**

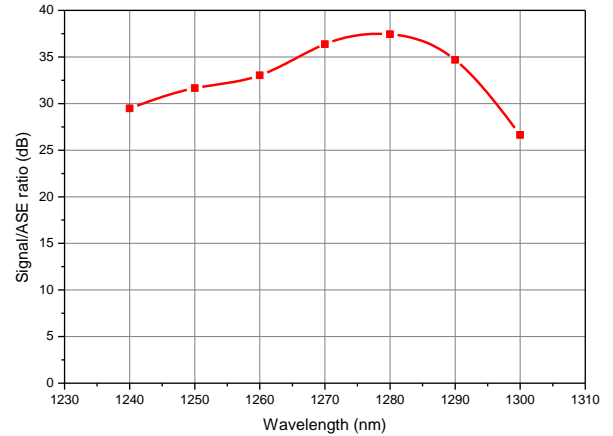

**Output power @ 1270 nm**

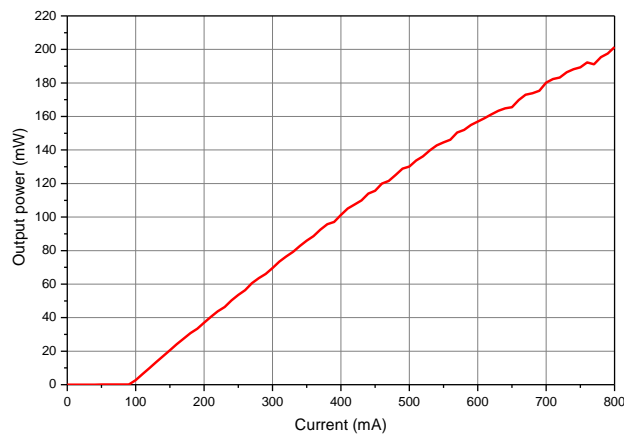

**Threshold current**

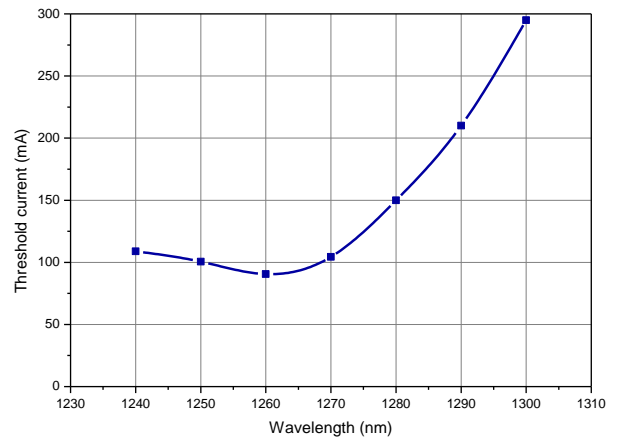

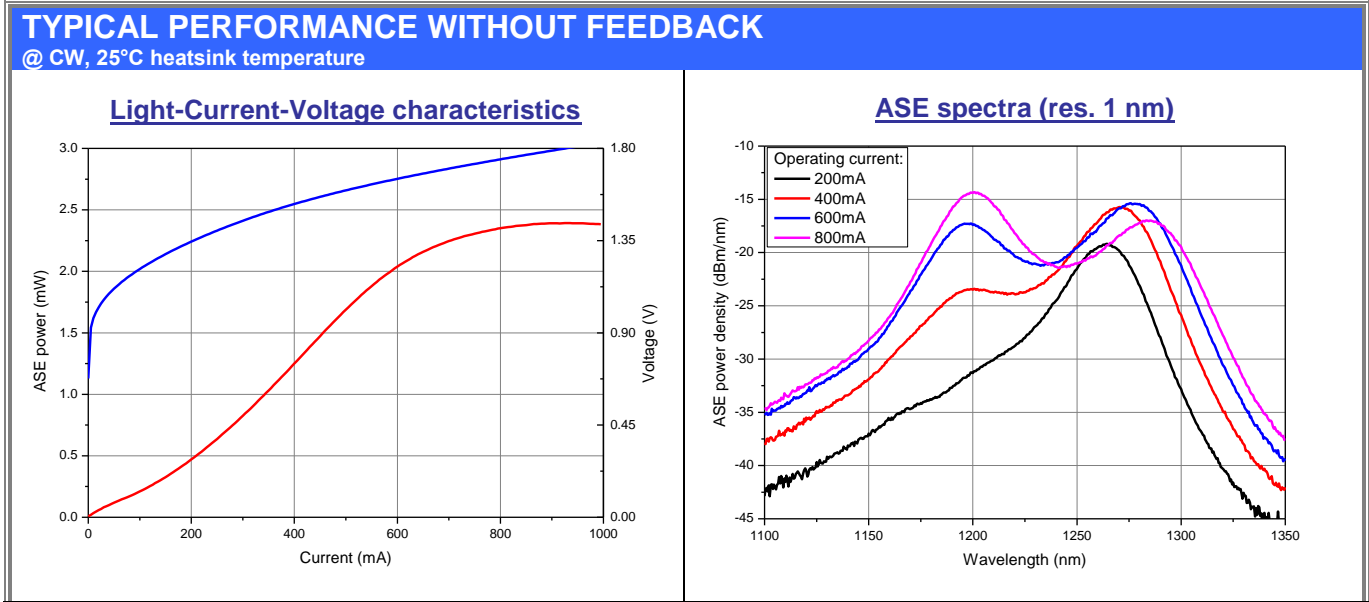

**ABSOLUTE MAXIMUM RATINGS**

Parameters	Min	Max	Unit
Diode reverse voltage		1	V
Forward current		1000	mA
Storage temperature (in original hermetically sealed package)	5	50	°C
Heatsink operating temperature	20	40	°C

**CHIP VISUAL ACCEPTANCE CRITERIA**

Top view: no indentations deeper 30um on cleaved edges, no scratches or indentations on mesa  
 Front facet view: no particles or defects of coating in 10-um area around mesa

## DIMENSIONS (subject to change)

(All sizes in mm)

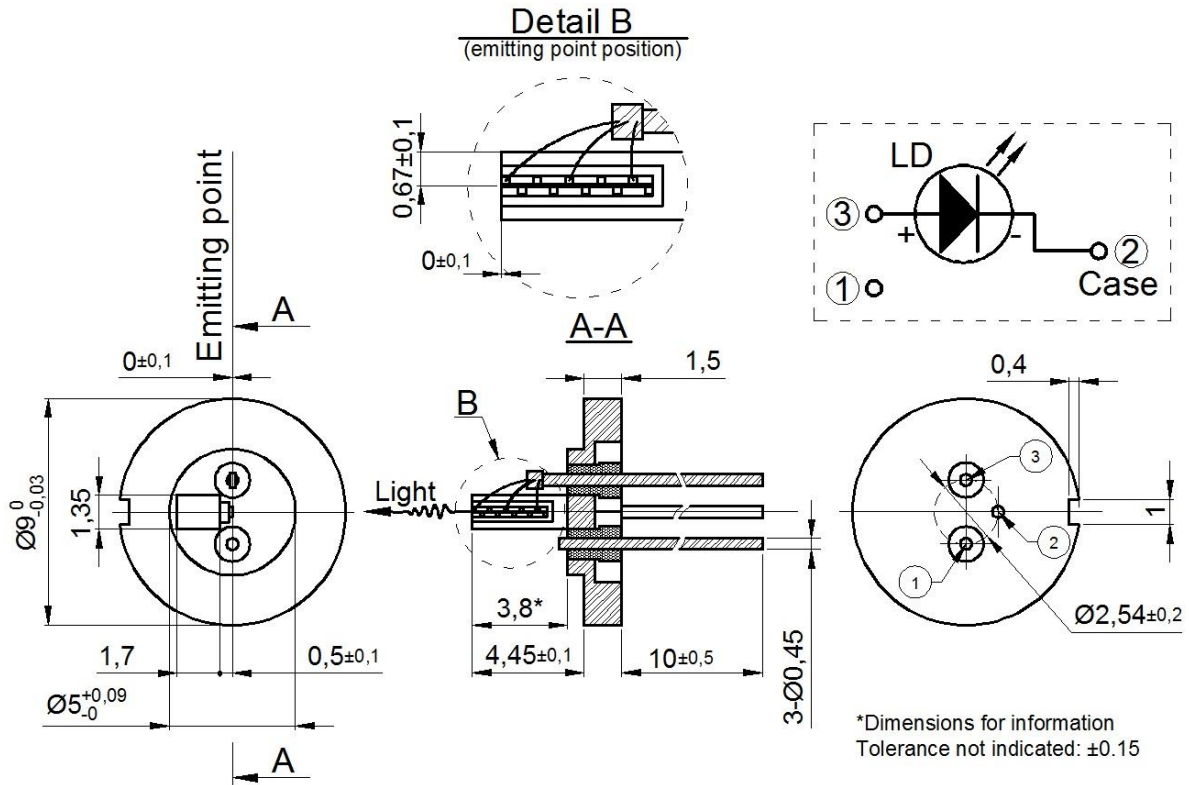

## SAFETY AND OPERATING INSTRUCTIONS

The laser light emitted from this device is invisible and can be dangerous to the human eye. Avoid looking directly into the fiber output or into the collimated beam along its optical axis when the device is in operation. Proper laser safety eyewear must be worn during operation.

Absolute Maximum Ratings may be applied to the device for short period of time only. Exposure to maximum ratings for extended period of time or exposure above one or more max ratings may cause damage or affect the reliability of the device.

Operating the product outside of its maximum ratings may cause device failure or a safety hazard. Power supplies used with the device must be employed such that the maximum peak optical power cannot be exceeded. A proper heatsink for the device on thermal radiator is required, sufficient heat dissipation and thermal conductance to the heatsink must be ensured.

The device is an open-heatsink laser diode; it may be operated in cleanroom atmosphere or dust-protected housing only. Operating temperature and relative humidity must be controlled to avoid water condensation on the laser facets. Any contamination or contact of the laser facet must be avoided.

ESD PROTECTION – Electrostatic discharge is the primary cause of unexpected product failure. Take extreme precaution to prevent ESD. Use wrist straps, grounded work surfaces and rigorous antistatic techniques when handling the product.



**NOTE:** Innolume product specifications are subject to change without notice.