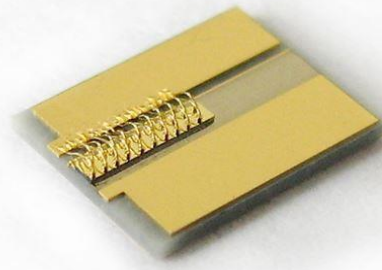

BA-1190-CoC-6W High Power Broad-Area Laser Diode on Submount	
	<p>Features:</p> <ul style="list-style-type: none"> • Output power 6W @ 1190nm in CW mode • Proprietary mirror coating technology enabling high reliability • Reliable Au/Sn bonding of chip to composite submount • RoHS compliance
<p>Applications:</p> <ul style="list-style-type: none"> • Medical Devices • Sensors • Scientific Research et al. 	
Rev: 01-01	Date: 26 Jan 2023

Recommended Operating Conditions				
Sample is mounted on a copper heatsink				
Parameter	Min.	Typ.	Max.	Unit
Heatsink Temperature		25		°C
Forward Current		14	15	A
Output Power	0.6		6	W

Characteristics				
Tested for each sample @ CW, 25C, 14A				
Parameter	Min.	Typ.	Max.	Unit
Output Power @ 15A	6			W
Forward Voltage		1.5	1.9	V
Threshold Current		1.1	1.5	A
Mean Wavelength	1180	1190	1200	nm
Bandwidth (FWHM)		10	15	nm
Wavelength Temperature Tunability		0.5		nm/°C
Slow Axis Beam Divergence (FWHM)	4	8	12	deg
Fast Axis Beam Divergence (FWHM)		40	46	deg
Mesa Width		250		µm
Polarization		TE		

Absolute Maximum Ratings			
Parameter	Min	Max	Unit
Forward Current (CW)		16	A
Reverse Voltage		2	V
Soldering Temperature (5 sec. max)		250	°C
Operating temperature (above dew point)	5	60	°C
Storage Temperature	-40	85	°C

Typical Performance (for reference only)

Light-Current-Voltage Characteristics

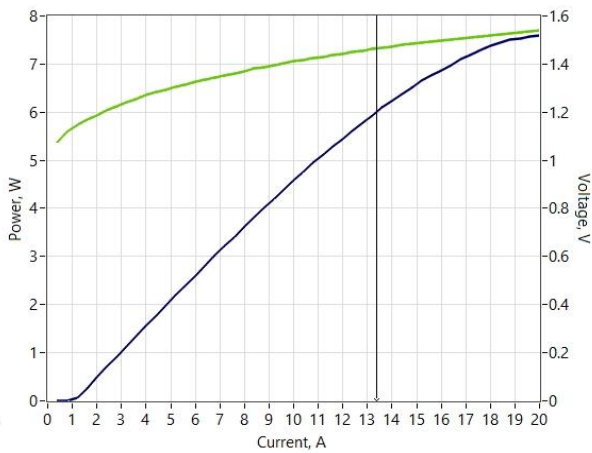

Optical Spectra (res. 1nm)

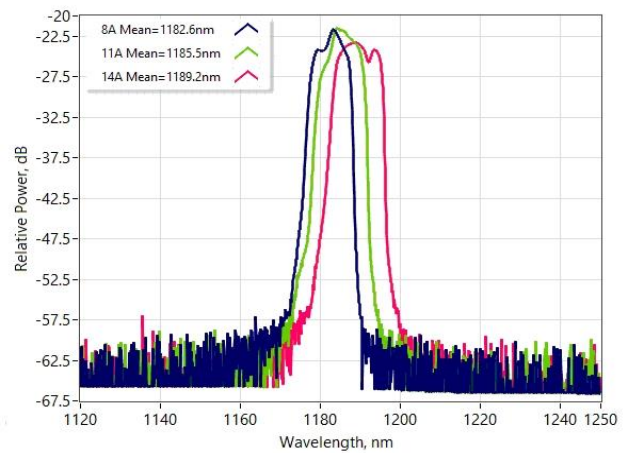

Slow Axis Far Field

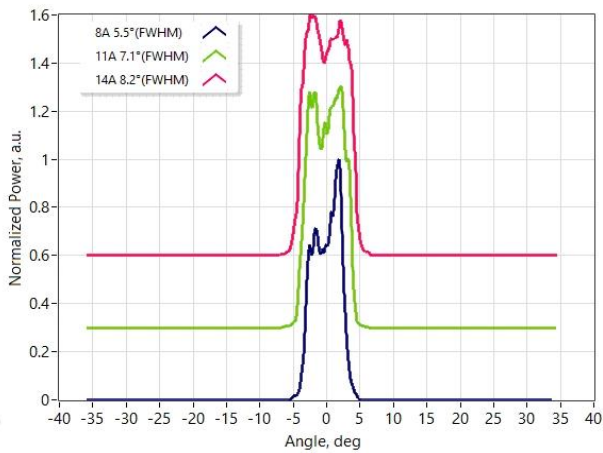

Fast Axis Far Field

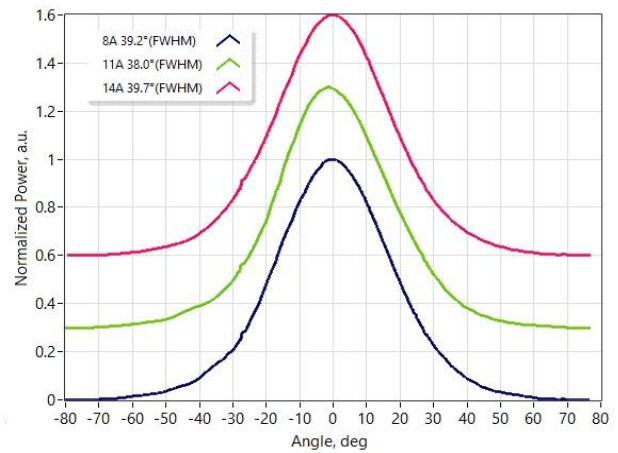

Dimensions (in mm)

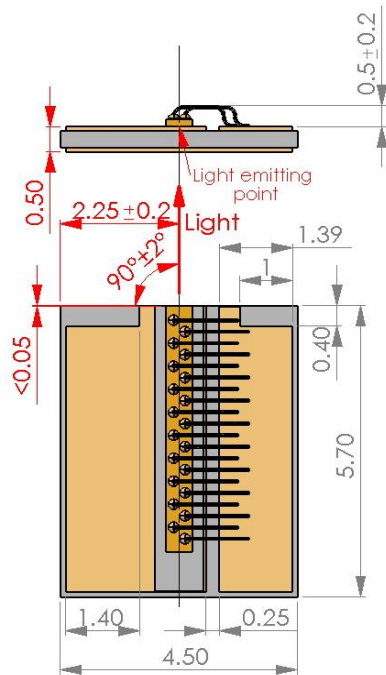

1. Tolerance not indicated ± 0.15 .
2. Red colored dimensions refer to emitting point.

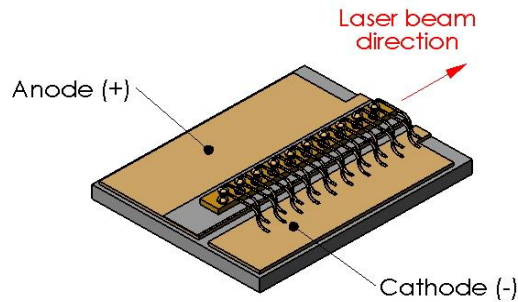

Safety and Operating Instructions

The laser light emitted from this Device is invisible and harmful to the human eye. Avoid looking directly into the fiber output or into the collimated beam along its optical axis when the device is in operation. Proper laser safety eyewear must be worn during operation.

Absolute Maximum Ratings may be applied to the Device for short period of time only. Exposure to maximum ratings for extended period of time or exposure above one or more max ratings may cause damage or affect the reliability of the Device.

Operating the product outside of its maximum ratings may cause device failure or a safety hazard. Power supplies used with the Device must be employed such that the maximum peak optical power cannot be exceeded. A proper heatsink for the Device on thermal radiator is required, sufficient heat dissipation and thermal conductance to the heatsink must be ensured by flux-free soldering.

The Device is an Open-Heatsink Diode Laser; it may be operated in cleanroom atmosphere or dust-protected housing only. Operating temperature and relative humidity must be controlled to avoid water condensation on the laser facets. Any contamination or contact of the laser facet must be avoided.

ESD PROTECTION – Electrostatic discharge is the primary cause of unexpected product failure. Take extreme precautions to prevent ESD. Use wrist straps, grounded work surfaces and rigorous antistatic techniques when handling the product.



Part-number Identification

BA-1190-CoC-6W - broad area laser with 6W output power at mean wavelength 1190nm

NOTE: Innolume product specifications are subject to change without notice

