

### SM-1030-YY-p1000

Fiber Coupled Laser Diode for Pulse or CW operation



#### Features:

- High peak optical power (1000mW)
- 400mW CW output power
- Broadened spectrum to exclude Brillouin scattering
- Individual burn-in and thermal cycling screening
- Proprietary mirror coating technology enabling high reliability
- Polarization maintaining PM980 fiber or HI1060 fiber
- 900um loose tube on fiber (optional)
- Built-in monitor photodiode (optional)

#### Applications:

- Seeding of Fiber Lasers
- Measurement Equipment (e.g. distance measurements)
- Scientific Research

### Recommended Operating Conditions

the case is mounted on room temperature heatsink

Parameter	Min.	Typ.	Max.	Unit
Chip Temperature	20	25	30	°C
Peak Forward Current @ Pulsed mode		2000	2300	mA
Output Peak Power @ Pulsed mode	50		1000	mW
Forward Current @ CW mode		800	1000	mA
Output Power @ CW mode	20		400	mW

### Pulsed Characteristics (500ns pulse width, 1% duty cycle)

25°C, 2000mA

Parameter	Min.	Typ.	Max.	Unit
Output Peak Power @ 2300mA	1000			mW
Mean Wavelength	1025	1030	1035	nm
Bandwidth (FWHM), res. 200pm	0.8	1.5	6	nm

### CW Characteristics

25°C, 800mA

Parameter	Min.	Typ.	Max.	Unit
Output Power @ 1000mA	400			mW
Forward Voltage		1.7	2.2	V
Threshold Current		65	150	mA
Mean Wavelength	1024	1030	1036	nm
Bandwidth (FWHM), res. 50pm		0.7	5	nm
Wavelength Temperature Tunability		0.35		nm/°C
Polarisation Extinction Ratio (PER)	15	18		dB
Polarization		TE		

**Typical Pulse Performance (for reference only)**

Test conditions: 500ns pulse width, 1% duty cycle

**Light Current Voltage Characteristics**

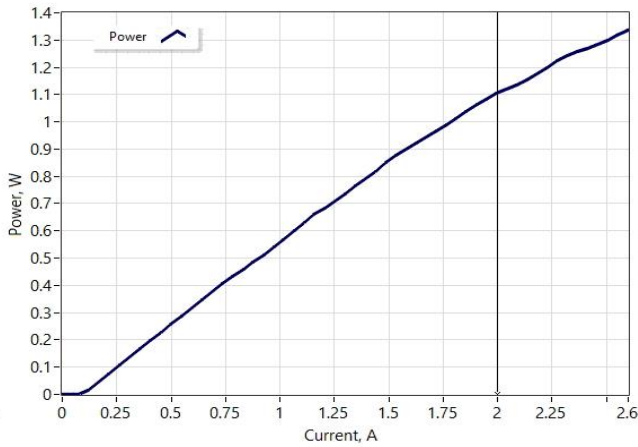

**Optical Spectra (res. 200pm)**

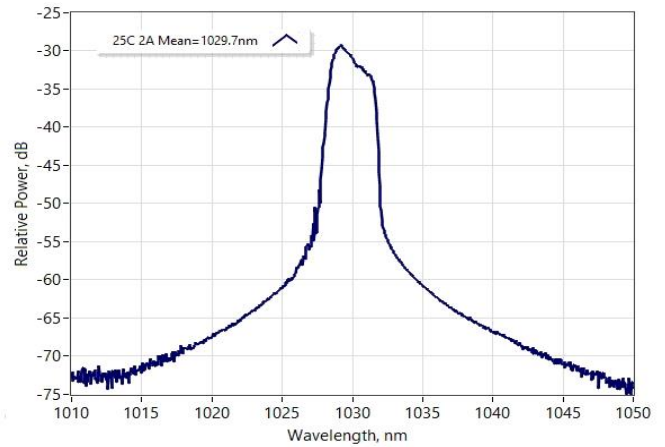

**Pulse shape\* @ 2000mA**

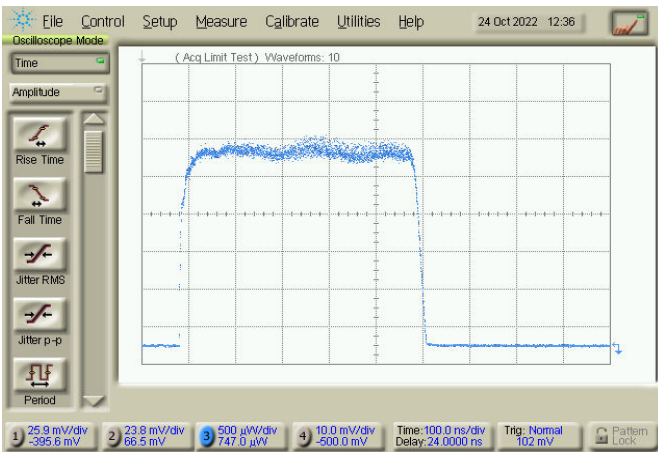

\*measured by 40GHz sampling oscilloscope with 20GHz optical channel

**Typical CW Performance (for reference only)**

**Light Current Voltage Characteristics**

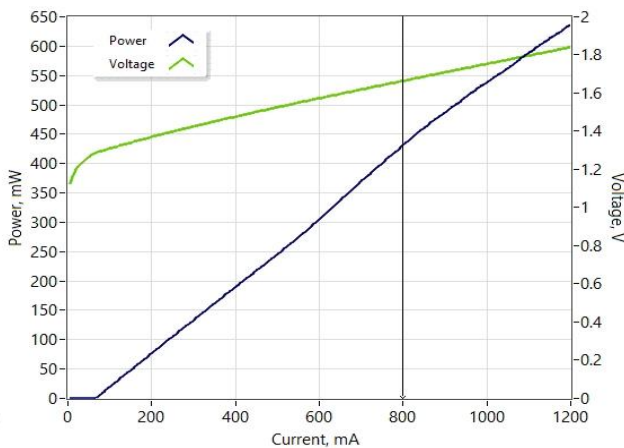

**Optical Spectra (res. 50pm)**

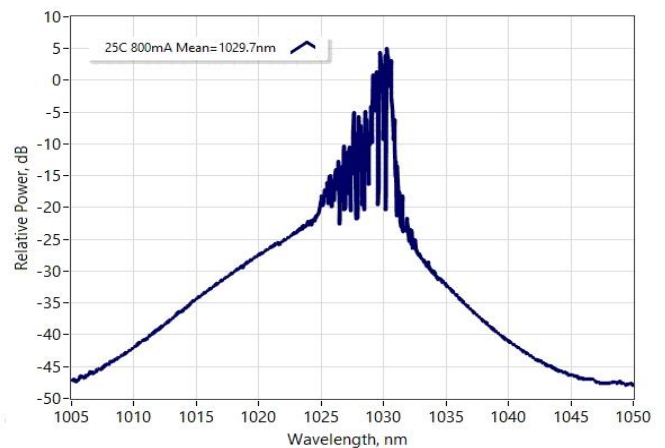

### Absolute Maximum Ratings

Parameter	Min	Max	Unit
Output Peak Power @ Pulsed mode (<1μs pulse width, <10% duty cycle)		1400	mW
Peak Forward Current @ Pulsed mode (<1μs pulse width, <10% duty cycle)		2600	mA
Output Power @ CW mode		650	mW
Forward Current @ CW mode		1200	mA
Reverse Voltage		2	V
TEC Current		3	A
TEC Voltage		4	V
Chip Operating Temperature	5	60	°C
Case Operating Temperature	0	70	°C
Storage Temperature	-40	85	°C
Fiber Band Radius	3		cm

### Thermistor specification

Parameters	Value	Unit
Type	NTC	
Resistance @ 25°C	10±0.1	kOhm
Beta 0-50°C	3430±1%	K

### Fiber specification

Parameters	Value	Value	Unit
Fiber Type	HI1060	PM980	
Numerical Aperture (Typical)	0.14	0.12	
Cut-off Wavelength	920±50	900±70	nm
Mode-Field Diameter	6.2±0.3 @1060nm	6.6±0.3 @1060nm	μm
Cladding Diameter	125±1	125±1	μm
Coating Diameter	245±15	245±15	μm
Loose Tube Diameter (optional)	900	900	μm
Connector	FC/APC	FC/APC	
Key	narrow	narrow	

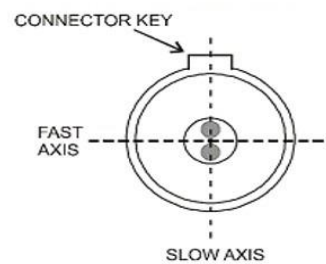
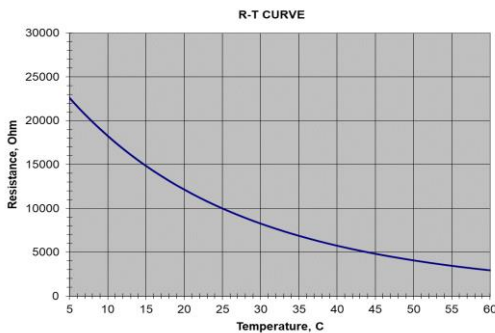

The output light is polarized along the slow axis of PM fiber.

### Dimensions (in mm)

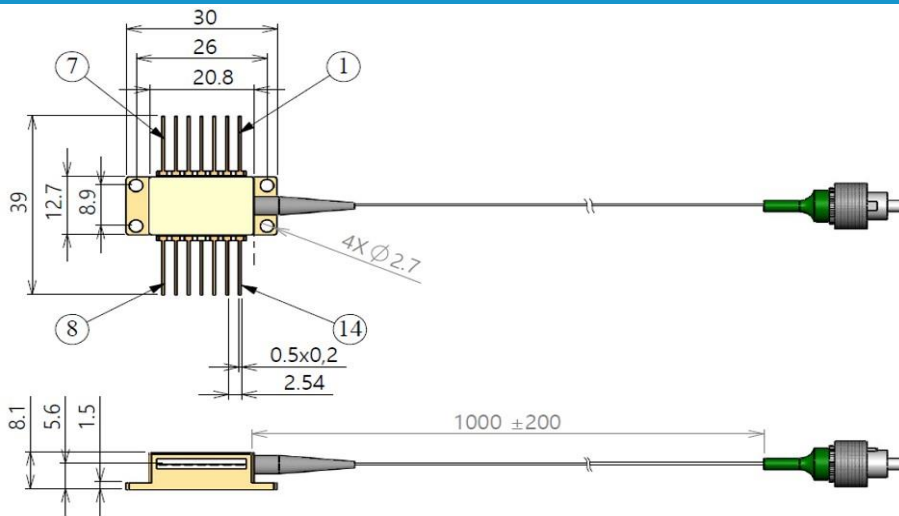

#### Pin identification:

1. TEC "+"
2. Thermistor
3. Monitor PD anode (" - ")
4. Monitor PD cathode (" + ")
5. Thermistor
6. -
7. -
8. -
9. -
10. LD anode (" + ")
11. LD cathode (" - ")
12. -
13. Case
14. TEC "-"

### Safety and Operating Instructions

The light emitted from this device is invisible and can be harmful to the human eye. Avoid looking directly into the fiber connector when the device is in operation. Proper laser safety eyewear must be worn during operation with open connector. Absolute Maximum Ratings may be applied to the device for short period of time only. Exposure to maximum ratings for extended period of time or exposure to more than one maximum rating may cause damage or affect the reliability of the device. Operating the device outside of its maximum ratings may cause device failure or a safety hazard. Power supplies used with the component must be employed such that the maximum forward current cannot be exceeded.

A proper heatsink for the device on thermal radiator is required. The device must be mounted on radiator with 4 screws (bolt down in X-style fashion with initial torque set to 0.075Nm and final X-style bolt down at 0.15Nm) or with clamps. The deviation from flatness of radiator surface must be less than 0.05mm. It's recommended using of Indium foil or thermal conductive and soft material between bottom of the case and heatsink for thermal interface. It's undesirable to use thermal grease for this. Avoid back reflection to the device. It may give impact on the device performance in aspects of spectrum and power stability. It also may cause fatal facet damage. Using of optical isolators is highly recommended to block back reflection.

Do not pull the fiber. Do not bend a fiber with a radius smaller than 3 cm. Fiber tip should always be protected from any contamination or damage during the process of installation. After removing the dust-preventing cap covered at fiber tip, carefully clean fiber tip by wiping through one direction using optical lens cleaning paper or cotton swab dabbed with Iso-Propanol or Ethyl alcohol. Operate the device with clean fiber connector only.

Electrostatic discharge is the primary cause of unexpected product failure. Take extreme precaution to prevent ESD. During device installation, ESD protection has to be maintained - use wrist straps, grounded work surfaces and rigorous antistatic techniques when handling the product.

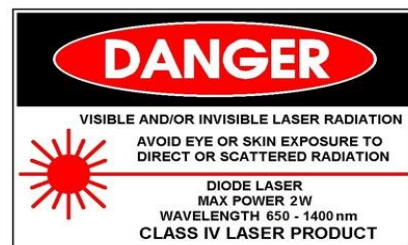

### Part-number Identification

SM-1030-HI-p1000 -> 1000mW pulse output power at 1030nm mean wavelength, HI-1060 fiber  
SM-1030-PM-p1000-PD-LT -> 1000mW pulse output power at 1030nm mean wavelength, PM-980 fiber, with built-in monitor photodiode and fiber loose tube

**NOTE:** Innolume product specifications are subject to change without notice

