

GC-1030-160-TO-100-B

Curved stripe gain chip on TO-header

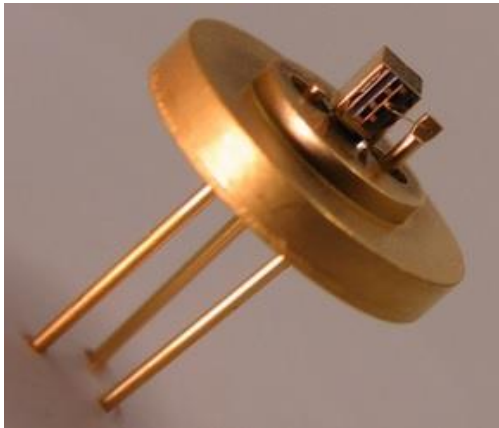

Features:

- Low beam divergence
- Optimized for wavelength locked operation in external cavity
- Broad hopping free tuning range
- High Side-Mode Suppression Ratio
- No self-lasing up to maximum operating current

Applications:

- External cavity diode lasers
- Tunable laser sources

Recommended Operating Conditions

Parameter	Min.	Typ.	Max.	Unit
Heatsink Temperature	20	25	30	°C
Forward Current*			200	mA
Optical Feedback**		20		%

*No self-lasing up to maximum current

** doesn't include coupling efficiency to chip.

Tunability Characteristics

Batch qualified @ CW, 25C, 200mA, external cavity in Littman configuration with 20% feedback

Parameter	Min.	Typ.	Max.	Unit
Wavelength of Maximum Power	1045	1060	1075	nm
Output Power @ 1060nm	80	110		mW
Central Wavelength of Tuning Range	1015	1030	1045	nm
Tuning Range Width (full)		160		nm
Side-Mode Suppression Ratio (SMSR) @ 1060nm		55		dB

Ampfified Spontaneous Emission (ASE) Characteristics

Tested for each sample @ CW, 25C, 200mA, without feedback

Parameter	Min.	Typ.	Max.	Unit
Output Power		5		mW
Forward Voltage		1.75	2.1	V
Mean Wavelength		1010		nm
Bandwidth (FWHM)*		60		nm
Fast Axis Beam Divergence (FWHM)	15	18	21	deg
Slow Axis Beam Divergence (FWHM)	5	8	11	deg
Polarization		TE		

* Radiation coupled in single-mode fiber without lens and measured by OSA with 1 nm resolution.

Chip Parameters

Parameter	Min.	Typ.	Max.	Unit
Chip length		1.5		mm
Back-reflection from Front Facet			0.1	%
Back-reflection from Back Facet	90	99		%

Typical Performance in External Cavity (for reference only)
 @ CW, recommended operating conditions, Littman configuration

Optical spectra (res. 0.5 nm)

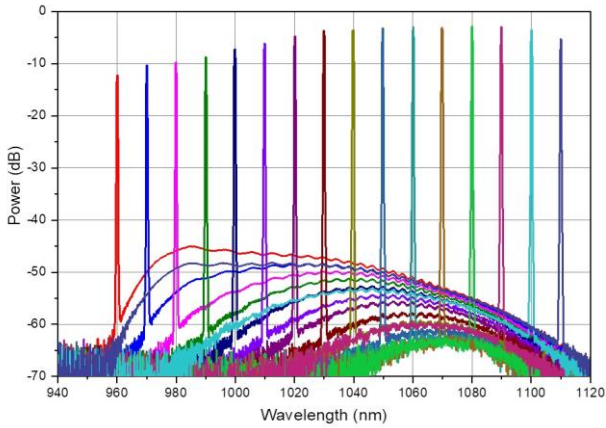

Optical spectrum (res. 10 pm)

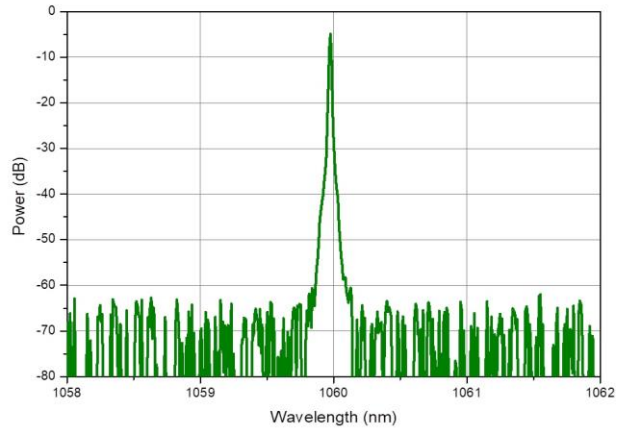

Output power spectra

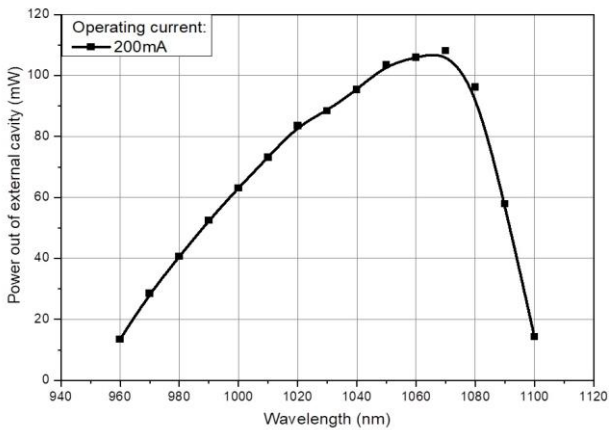

Integrated Signal/ASE ratio

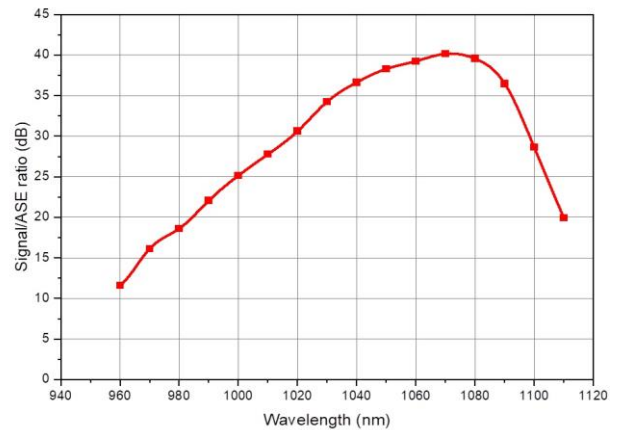

Output power @ 1060nm

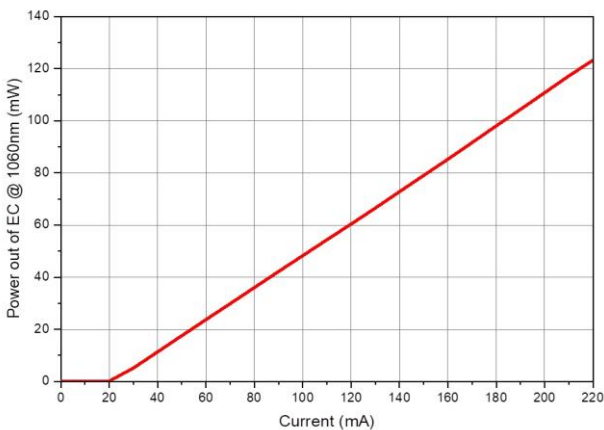

Threshold current

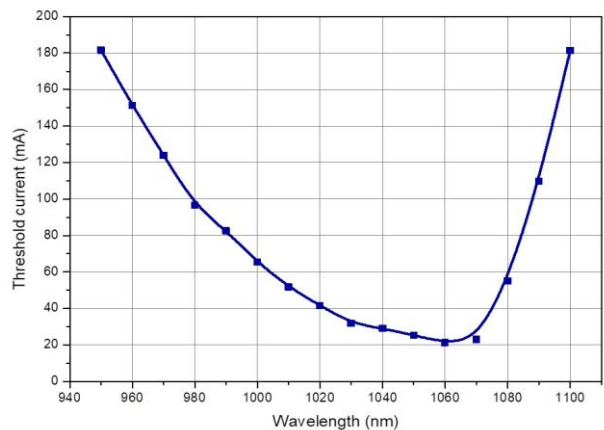

Typical Performance without feedback (for reference only)

L-I-V curve

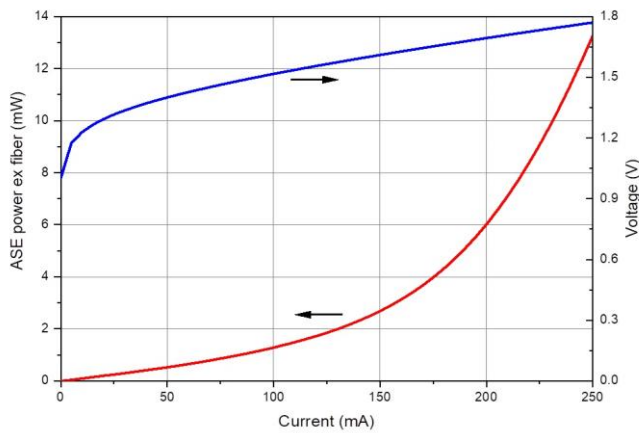

ASE spectra (res. 1nm)

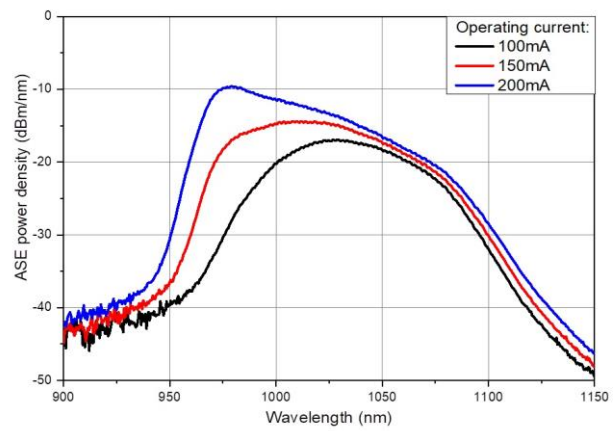

Absolute Maximum Ratings

Parameter	Min	Max	Unit
Forward Current @ 20% feedback		220	mA
Optical Feedback (doesn't include coupling to a chip)		25	%
Reverse Voltage		1	V
Operating temperature (above dew point)	-10	60	°C
Storage Temperature (in original hermetically sealed package)	-40	85	°C

Drawing

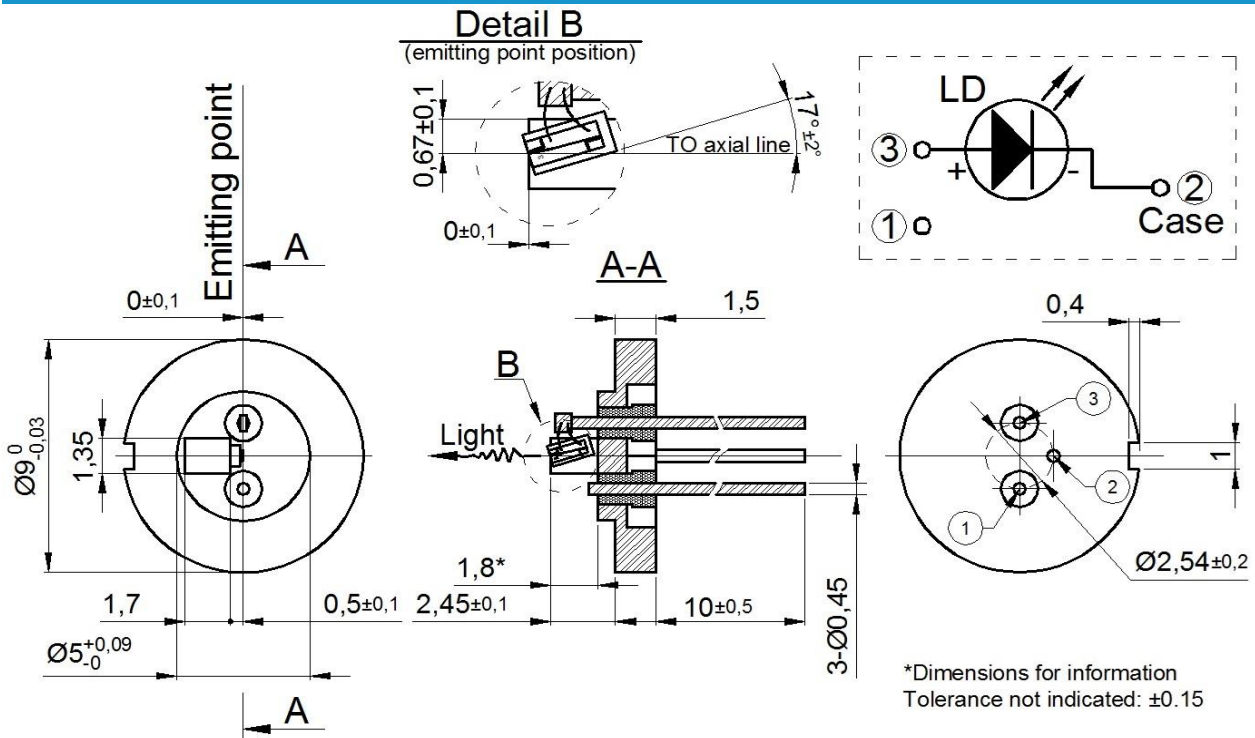

Safety and Operating Instructions

The laser light emitted from this device is invisible and can be dangerous to the human eye. Avoid looking directly into the fiber output or into the collimated beam along its optical axis when the device is in operation. Proper laser safety eyewear must be worn during operation.

Absolute Maximum Ratings may be applied to the device for short period of time only. Exposure to maximum ratings for extended period of time or exposure above one or more max ratings may cause damage or affect the reliability of the device. Operating the product outside of its maximum ratings may cause device failure or a safety hazard. Power supplies used with the device must be employed such that the maximum peak optical power cannot be exceeded. A proper heatsink for the device on thermal radiator is required, sufficient heat dissipation and thermal conductance to the heatsink must be ensured. The device is an open-heatsink laser diode; it may be operated in clean atmosphere or dust-protected housing only. Operating temperature and relative humidity must be controlled to avoid water condensation on the laser facets. Any contamination or contact of the laser facet must be avoided.

ESD PROTECTION - Electrostatic discharge is the primary cause of unexpected product failure. Take extreme precaution to prevent ESD. Use wrist straps, grounded work surfaces and rigorous antistatic techniques when handling the product.



NOTE: Innolume product specifications are subject to change without notice

