

SM-1020-YY-400

Fiber Coupled High Power Fabry-Perot Laser Diode

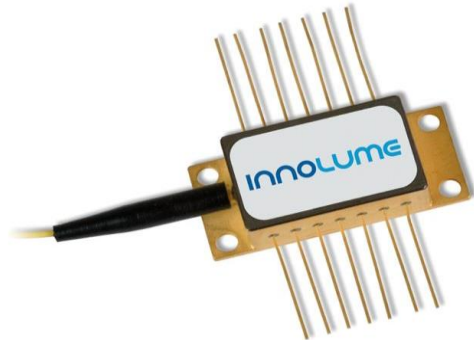

Features:

- Kink-free operation up to 400mW at 1020nm
- Individual burn-in and thermal cycling screening
- Proprietary mirror coating technology enabling high reliability
- Built-in monitor photodiode (optional)
- 900um loose tube on fiber (optional)

Applications:

- Thulium Doped Fiber Amplifier (TDFA) pumping

Recommended Operating Conditions

@ CW, the case is mounted on room temperature heatsink

Parameter	Min.	Typ.	Max.	Unit
Chip Temperature	20	25	30	°C
Forward Current		800	850	mA
Output Power**	50		400	mW

* in some cases may vary

** kink-free over the entire range

Characteristics

@ CW, 25°C*, 800mA

Parameter	Min.	Typ.	Max.	Unit
Output Power @ 850mA	400			mW
Forward Voltage		1.9	2.1	V
Threshold Current		60	120	mA
Mean Wavelength	1015	1020	1025	nm
Bandwidth (FWHM)		0.2	4	nm
Wavelength Temperature Tunability		0.35		nm/°C
Polarisation Extinction Ratio (PER)	15	17		dB
Polarisation		TE		

* in some cases may vary in 20-30°C range.

Absolute Maximum Ratings

Parameter	Min	Max	Unit
Forward Current		1000	mA
Reverse Voltage		2	V
TEC Current		3	A
TEC Voltage		4	V
Chip Operating Temperature	5	40	°C
Case Operating Temperature	0	70	°C
Storage Temperature	-40	85	°C
Fiber Band Radius	3		cm

Typical Performance (for reference only)

Light Current Voltage Characteristics

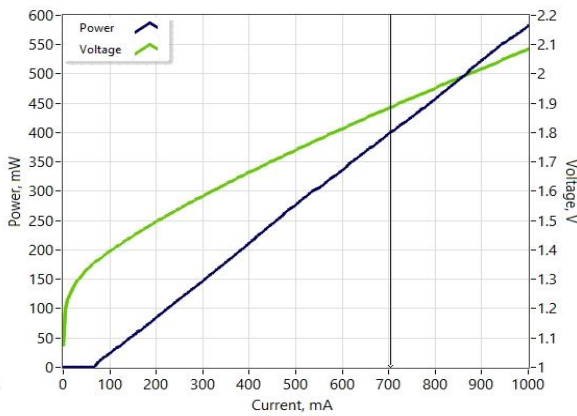

Optical Spectra (res. 500pm)

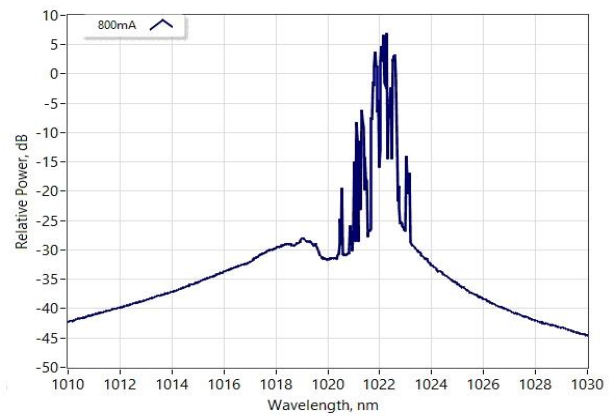

Thermistor specification			Fiber specification			
Parameters	Value	Unit	Parameters	Value	Value	Unit
Type	NTC		Fiber Type	HI1060	PM980	
Resistance @ 25°C	10±0.1	kOhm	Numerical Aperture (Typical)	0.14	0.12	
Beta 0-50°C	3430±1%	K	Cut-off Wavelength	920±50	900±70	nm
			Mode-Field Diameter	6.2±0.3 @1060nm	6.6±0.3 @1060nm	µm
			Cladding Diameter	125±1	125±1	µm
			Coating Diameter	245±15	245±15	µm
			Loose Tube Diameter (optional)	900	900	µm
			Connector	FC/APC	FC/APC	
			Key	narrow	narrow	

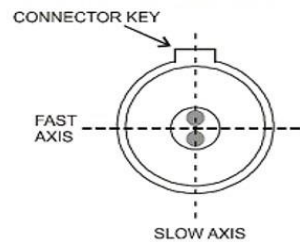
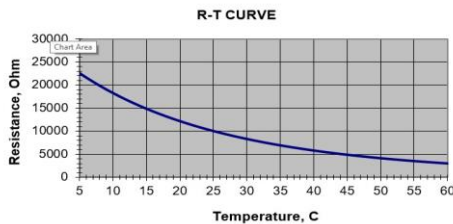

The output light is polarized along the slow axis of PM fiber.

Dimensions (in mm)

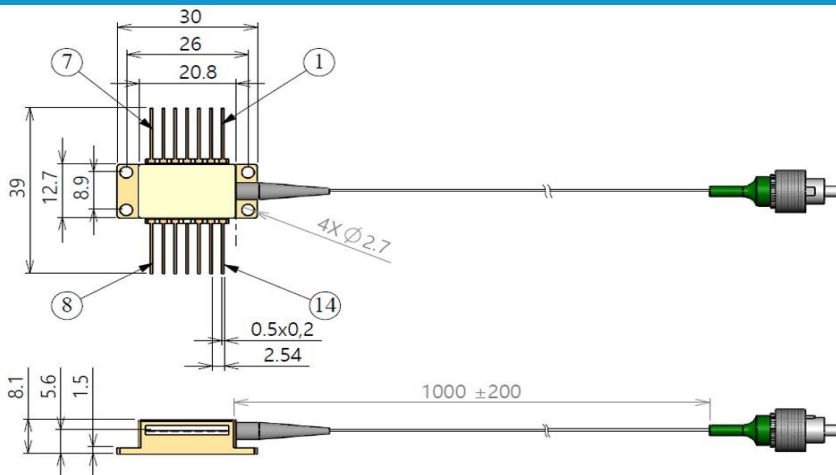

- Pin identification:**
1. TEC "+"
 2. Thermistor
 3. Monitor PD anode ("-")
 4. Monitor PD cathode ("+")
 5. Thermistor
 6. -
 7. -
 8. -
 9. -
 10. LD anode ("+")
 11. LD cathode ("-")
 12. -
 13. Case
 14. TEC "-"

Safety and Operating Instructions

The light emitted from this device is invisible and can be harmful to the human eye. Avoid looking directly into the fiber connector when the device is in operation. Proper laser safety eyewear must be worn during operation with open connector. Absolute Maximum Ratings may be applied to the device for short period of time only. Exposure to maximum ratings for extended period of time or exposure to more than one maximum rating may cause damage or affect the reliability of the device. Operating the device outside of its maximum ratings may cause device failure or a safety hazard. Power supplies used with the component must be employed such that the maximum forward current cannot be exceeded.

A proper heatsink for the device on thermal radiator is required. The device must be mounted on radiator with 4 screws (bolt down in X-style fashion with initial torque set to 0.075Nm and final X-style bolt down at 0.15Nm) or with clamps. The deviation from flatness of radiator surface must be less than 0.05mm. It's recommended using of Indium foil or thermal conductive and soft material between bottom of the case and heatsink for thermal interface. It's undesirable to use thermal grease for this. Avoid back reflection to the device. It may give impact on the device performance in aspects of spectrum and power stability. It also may cause fatal facet damage. Using of optical isolators is highly recommended to block back reflection.

Do not pull the fiber. Do not bend a fiber with a radius smaller than 3 cm. Fiber tip should always be protected from any contamination or damage during the process of installation. After removing the dust-preventing cap covered at fiber tip, carefully clean fiber tip by wiping through one direction using optical lens cleaning paper or cotton swab dabbed with Iso-Propanol or Ethyl alcohol. Operate the device with clean fiber connector only.

Electrostatic discharge is the primary cause of unexpected product failure. Take extreme precaution to prevent ESD. During device installation, ESD protection has to be maintained - use wrist straps, grounded work surfaces and rigorous antistatic techniques when handling the product.



Part-number Identification

SM-1064-HI-400 -> 400mW output power at 1064nm mean wavelength, HI-1060 fiber

SM-1064-PM-400-PD-LT -> 400mW output power at 1064nm mean wavelength, PM-980 fiber, with built-in monitor photodiode and fiber loose tube

NOTE: Innolume product specifications are subject to change without notice

Revision history

Rev	Date	Description
01	16 Jan 2023	Initial issue of the document